

FEATURES AND SPECIFICATIONS

LENS: Cine-Nikkor Zoom

Zoom Range: 8.8 mm to 45 mm

Zoom Time: Approximately 6 seconds, powered

Focusing Range: 4 feet to ∞ (infinity)

Available Apertures: f/1.8 to f/16.

FILM DRIVE: Battery powered.

Speeds: 12, 18 and 24 fps.

EXPOSURE SYSTEM: Fully automatic CdS, mercury battery powered, with provision for manual override. Through-The-Lens sensing. Automatic compensation for film drive speeds.

VIEWFINDER: Reflex prismatic, with diopter correction for personal vision. Viewfinder displays: aperture scale for manual and automatic lens aperture selection, over- and under-exposure warnings, end-of-film signal.

RANGEFINDER: Split-image, built into viewfinder screen.

BATTERY CHECK: Two-way switch checks mercury batteries for exposure system and penlite batteries for film drive and Auto-Zoom. Uses aperture scale needle in viewfinder as indicator.

PISTOL GRIP: Provides steadiness in filming. Also serves as battery chamber for penlite batteries. Permanently attached; folds away when not in use.

FOOTAGE COUNTER: Automatically resets to "0" when film chamber is opened. Gear-driven for accuracy and durability.

TYPE-A FILTER: Remains in light path unless Super-8 Movie Light is inserted in keyway. If other lights are used, special key provided swings filter out of the light path.

TOTAL-CLOSE DIAPHRAGM: Lens diaphragm may be fully closed to shoot fade effect in the camera.

TWO-STEP TRIGGER: First position actuates exposure system. Second position starts film-drive. Permits light readings without running camera and preserves life of mercury batteries.

REMOTE CONTROL: With accessory cable, camera may be run from distance of up to 10 feet.

SINGLE-FRAME EXPOSURE: Single frame exposure is possible by a cable release connected to the socket.

FILM: Kodapak Super-8 Cartridges. Instant drop-in loading and drop-out unloading. No threading. No run-off of film-leader. Format is 50% larger than conventional double-8 film.

Daylight typeASA 10-250

Artificial light typeASA 16-400

COMPONENT PARTS

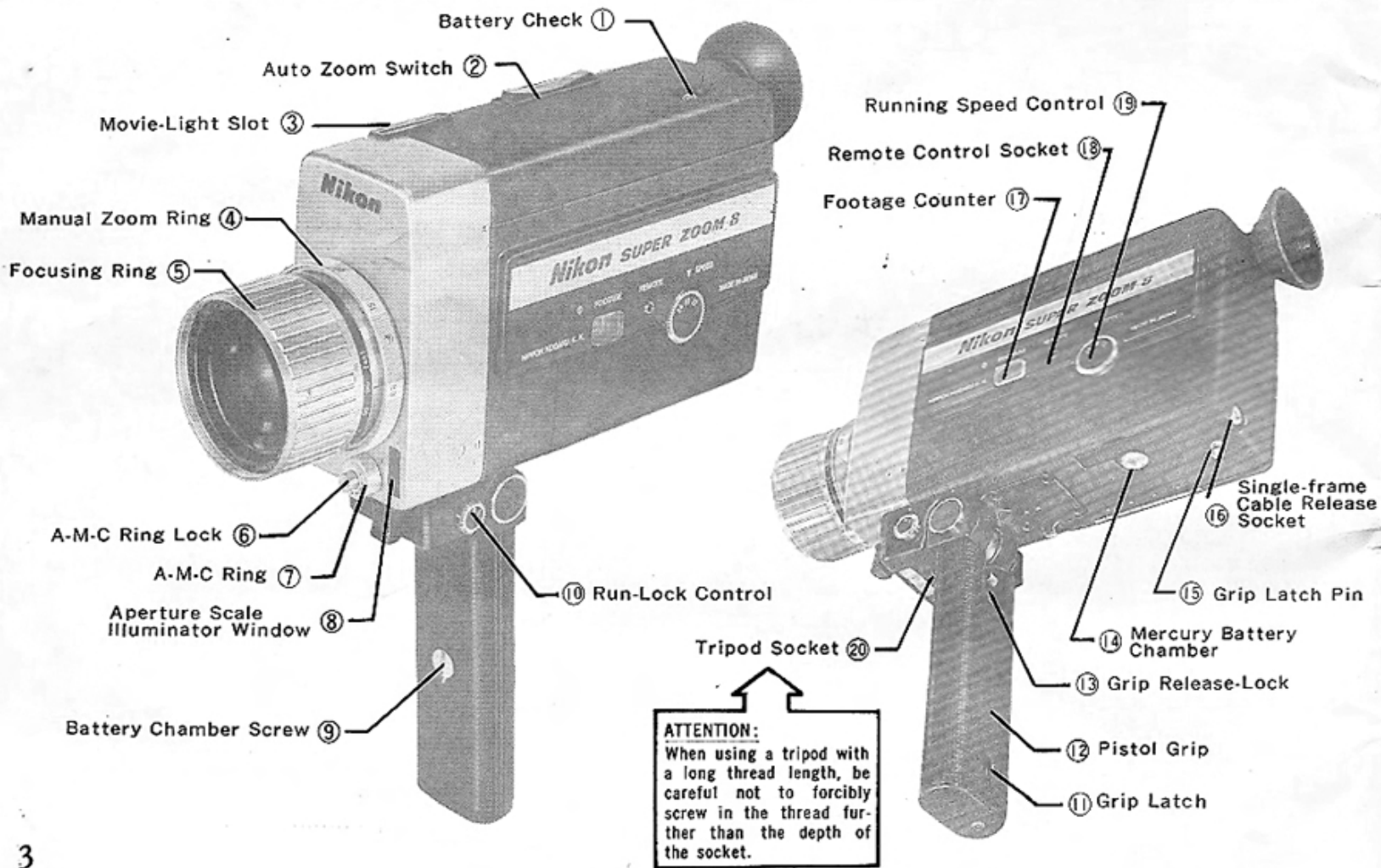

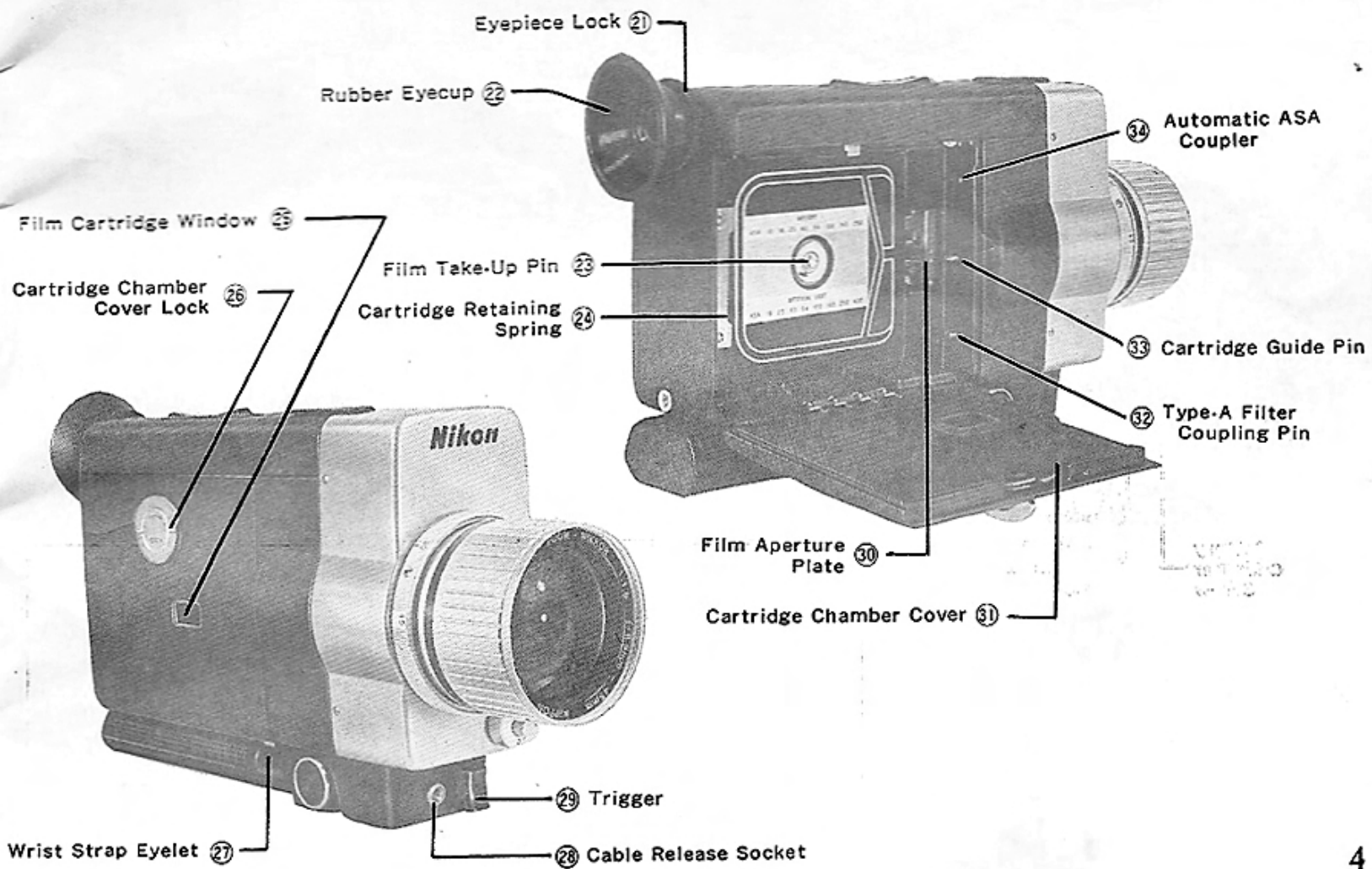

THE TWO BATTERY-POWERED SYSTEMS

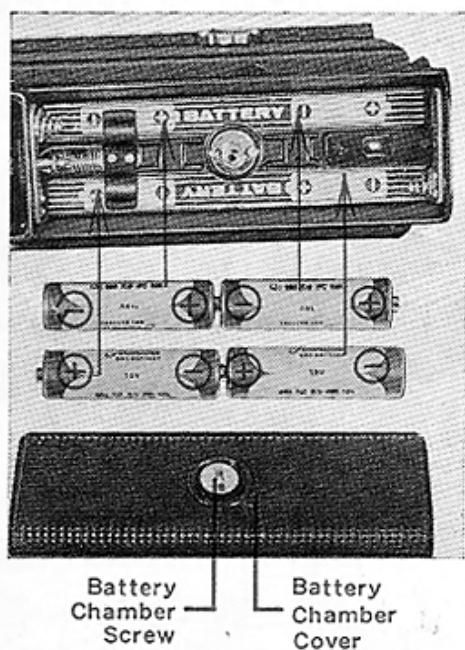

■ Film Transport and Auto-Zoom

Four 1.5 V penlite batteries, located in the Pistol Grip ⑫ power the film transport of more than 20 rolls and the Auto-zoom lens. To install or replace these batteries, remove the cover of the battery chamber by loosening the Battery Chamber Screw ⑨ with a small coin. Be sure the correct positive-negative (+, -) orientation of the batteries is followed, as shown in the accompanying diagram, and as indicated inside the battery chamber. Replace the cover and tighten the Screw.

Note: Ordinary zinc-carbon batteries may be used, but manganese-alkaline batteries are recommended for their longer life.

■ Penlite Battery Check

Place a finger on the Battery Check Button ① and hold the camera to your eye. Push the Button toward you, so that the mark "P" aligns with the index. Observe the aperture scale above the frame in the viewfinder. The aperture needle should swing anywhere beyond the red diamond ◆ (check point) to the right. If it does not, the batteries are exhausted and must be replaced, or they have been placed incorrectly in the Battery Chamber.

■ **Battery-Powered CdS Automatic Exposure System**

Two 1.3 V mercury batteries, (Mallory PX-13, RM-625, PX-625, National M-1D), power the fully automatic CdS exposure system. These are located in the Mercury Battery Chamber ⊕, under the Pistol Grip. These batteries are supplied installed in the camera. Normally, they will last for several years of use.

When replacement is necessary, the batteries are removed by loosening the Mercury Battery Chamber Screw and lifting out the Mercury Battery Carrier. Note that the batteries can be installed in the carrier in only one way, and that the carrier will only slip into the camera body in the correct way. For reference, positive-negative (+, -) orientation is engraved on the carrier.

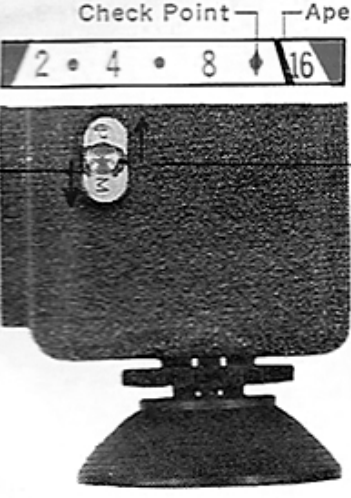
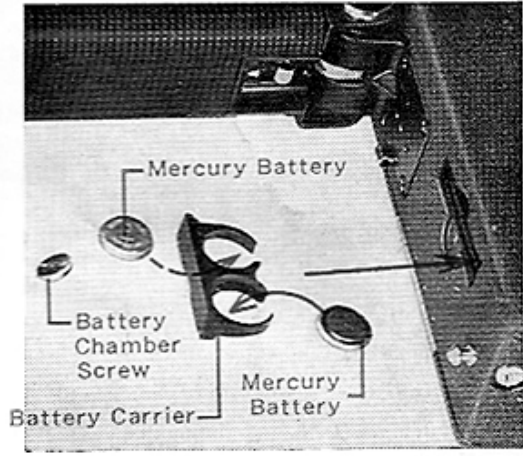

■ **Mercury Battery Check**

To check the mercury batteries, follow the same procedure as for the penlite batteries, except that the Battery Check Button is pushed away from you so that the mark "M" aligns with the index. Again, the needle should swing anywhere beyond the red diamond ♦ (check point) to the right.

LOADING

The Nikon Super Zoom-8 Camera accepts the new Kodapak instant-load cartridges. These contain 50 feet of Super-8 movie film which is exposed "straight-through", without flipping after the first 25 feet have been shot.

Open the Cartridge Chamber Cover ③① by turning the Lock ②⑥ fully in the direction indicated by the arrow. Swing the cover open. Drop a Kodapak cartridge into the Chamber, front first, with the Cartridge Guide Pin ③③ slipping into its notch in the cartridge. Push the rear of the cartridge down until it clicks into position.

If correctly positioned, the label on the cartridge will be up, facing you. Then, swing the cover shut and close the Lock. The film type designation on the cartridge label will be visible through the Film Cartridge Window ②⑤.

■ Footage Counter

The Footage Counter ①⑦ on the opposite side of the camera body will now point to "0". This counter resets itself to "0" whenever the camera is opened.

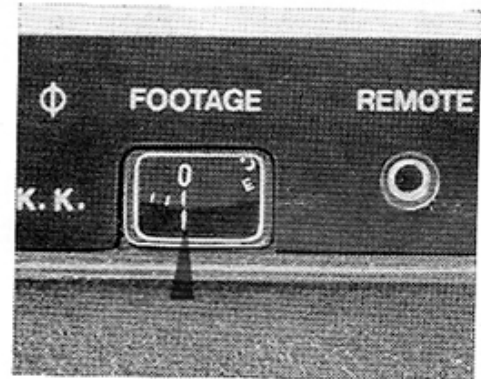
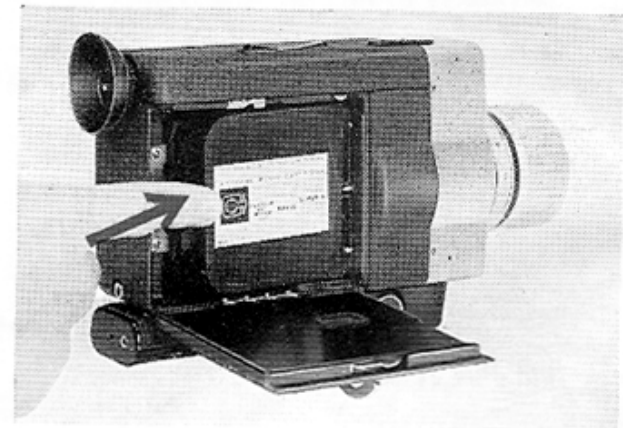

“SETTING-UP” FOR STANDARD SHOOTING

■ Running Speed Control

Normally, silent films are shot at 18 frames-per-second. To set the camera for this speed, rotate the Running Speed Control ⑨ until the number 18 aligns with the white triangle.

While most sound projectors will record and play at 18 or 24 frames-per-second, sound is improved at the faster speed. Therefore, if a sound track will later be added to your film, it is recommended that you shoot at 24 frames-per-second. Align the number 24 with the white triangle above the Control. The use of 12 frames-per-second speed will be discussed later. Rotate the A-M-C Ring ⑦ until “A” (automatic) aligns with the black dot. Note that the Ring clicks into this position, and cannot be accidentally jarred out of alignment.

Swing the Pistol Grip down until it clicks into position. Turn the Run-Lock Control ⑩ until “R” (run) aligns with the white dot. Attach the wrist strap to its eyelet ⑳.

Since inserting the cartridge in the Film Chamber automatically sets the exposure system for film sensitivity, your Nikon is now “set up”, and ready to shoot.

■ Run-Lock Control

Set the Run-Lock Control to the position “R” and the Trigger will freely be pushed. If the Trigger in the depressed position is locked by setting the control knob to “L”, the film is kept in continuous running. When the camera is not in use, it is best to return the Run-Lock Control to “L” (lock) to avoid accidental exposures.

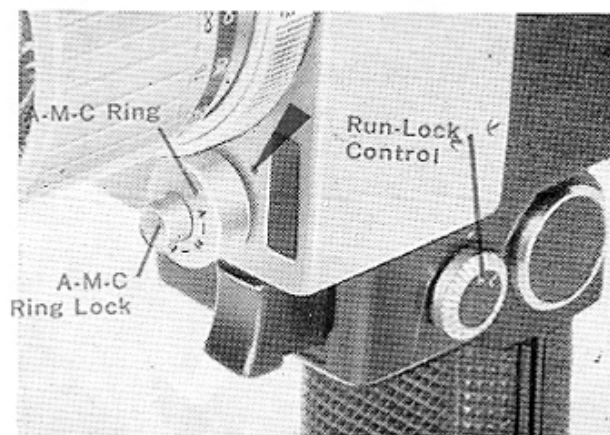
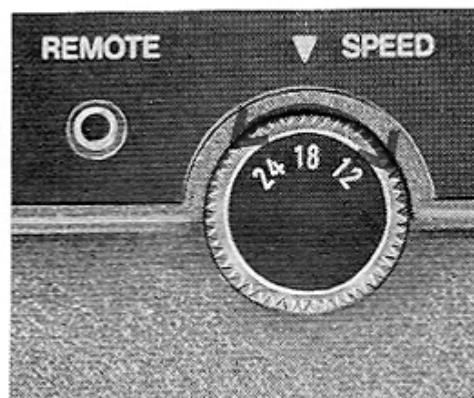

LOOK THROUGH THE VIEWFINDER

The viewfinder gives you several important items of filming information at a glance.

■ Bright, Erect Viewing through the Lens

The scene at which the camera is pointed, and which is covered by the lens, is clearly delineated within the frame of the finder. The field is actually carried from the lens to your eye by an internal system of prisms. You're looking through the lens!

■ Eyesight Adjusting

In the center of the viewing screen is a split-image rangefinder. Loosen the Eyepiece Lock Ring by turning it to the left and adjust this rangefinder image to your personal vision by rotating the Eyecup until the horizontal line dividing the two halves of the rangefinder appears sharp. Then, lock the eyepiece in this position by turning the Eyepiece Lock ②!

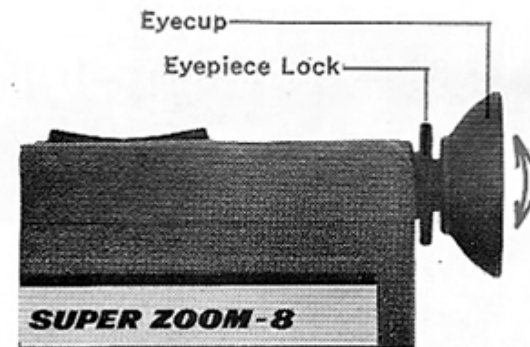

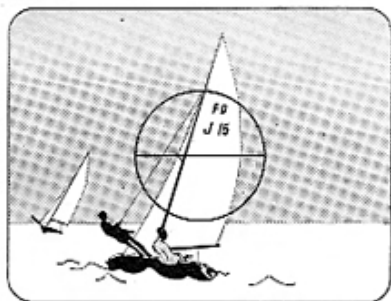
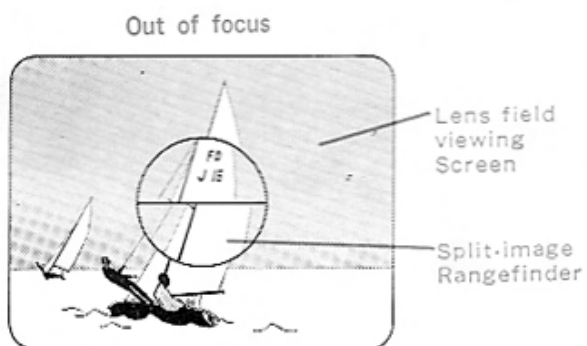

Focused

■ Focusing by Split-Image

If the camera is out-of-focus, all vertical lines will appear to be broken in the rangefinder. Rotate the Focusing Ring ⑤ until these lines appear continuous and unbroken.

■ For Critical Focusing at a Closer Distance

1. Zoom the lens fully out to its telephoto position because the shallowest depth-of-field* is obtained at this position.
(See: p. 11)

* For depth-of-field, refer to the tables on p. 24—33.

2. Rotate the Focusing Ring until the split-images appear continuous and unbroken.
3. Zoom the lens back until the desired field is covered.

ZOOMING

Your Nikon Super Zoom-8 movie camera is equipped with a 5.1X zoom lens of incomparable quality. It may be used as a valuable filming tool in two different ways.

■ Zoom Effects (Auto-Zooming)

The lens travels its full range from 8.8 mm wide-angle to 45 mm telephoto in about 6 seconds when the Auto-zoom feature is used.

To zoom-up to telephoto, press the "T" position on the Auto-Zoom Switch ②. Everything will appear to move in toward the camera, and objects will grow larger. This effect is observable in the viewfinder.

To zoom-away to wide-angle, press the "W" position, and the opposite effect occurs. Zooming the lens while the camera is running causes the same effect to be captured on the film that you observe in the viewfinder. If a total zoom is not desired, the Switch may be released at any point, and the lens will instantly stop its zoom-travel.

■ Manual Focal-Length Settings

A very valuable feature of the zoom lens is its capacity to be set anywhere between its telephoto and wide-angle extremes for pleasant, frame-filling compositions.

For accurate settings, rotate the Manual Zoom Ring ④ until the viewfinder shows the desired coverage of field. The focal-length at which the lens is set may be read on the scale provided on the Manual Zoom Ring. The setting is that which is aligned with the black indicator line on the left side of the lens barrel.

T W



Auto-zooming



Manual-zooming

SHOOTING

■ To Check for Correct Exposure

Hold the camera by the Pistol Grip, with the viewfinder to your eye, and permit your index finger to rest on the Trigger 29. Press the Trigger lightly, to its first click-stop position. The camera will not run but the aperture needle will swing into the aperture scale. If the needle swings anywhere between f/1.8 (the white area just before "2") and f/16, the light is all right, and exposure will be correct.

The aperture scale tells you what lens opening the automatic exposure system has selected for correct exposure. It is also extremely useful when manual exposure settings are made, as will be explained later. For convenience, several of the intermediate aperture values in the scale have been represented by symbols, as shown below.

■ To Run the Camera

Hold the camera as before, and press the Trigger fully in. The automatic exposure system will operate, as described above, and the camera will operate.

Adjacent to the Trigger on the front of the camera, there is a Cable Release Socket 28. Make use of this when filming with the camera set on a tripod or in other cases.

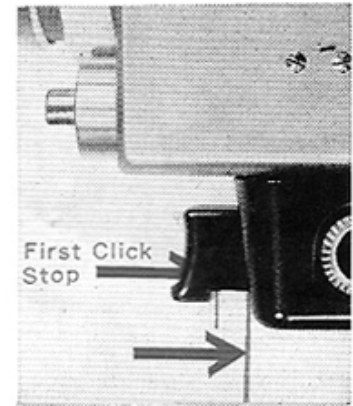

Under-exposure Flag Aperture Needle Over-exposure Flag

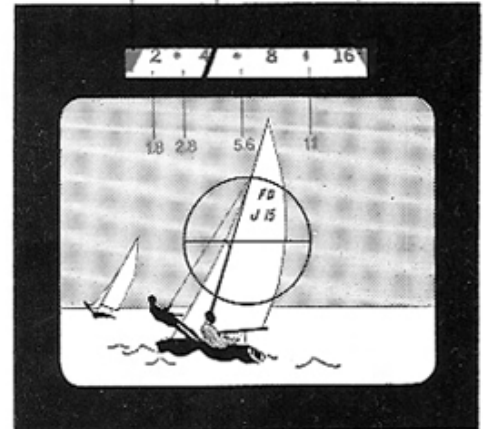

■ Poor Exposure Warnings

At the left extreme of the aperture scale is a red area ③. When the aperture needle points to this area, it is a warning that the light is not bright enough for good exposure, and a higher sensitive film, a slower filming speed or artificial light must be used.

At the extreme right is a second red area ④ that warns you when the light is too bright. In this case, a less sensitive film must be used, or a faster filming speed, or a neutral-density (ND) filter—precisely calibrated gray filter that cuts the intensity of light without affecting color—over the lens.

■ Film-End Warning

When you have reached 50 feet, the end of the film in the cartridge, a red square will appear in the lower left corner of the viewfinder. This is your signal to stop and re-load.

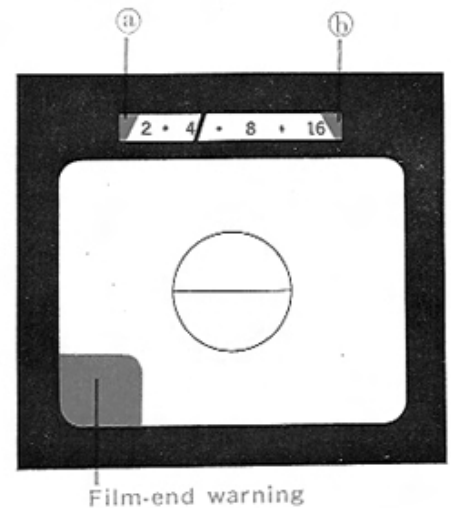

Note: When rotating the A-M-C Ring, be careful not to cover the Aperture Scale Illuminator Window ⑤ with your hand, or the aperture scale will dim out or disappear in the viewfinder.

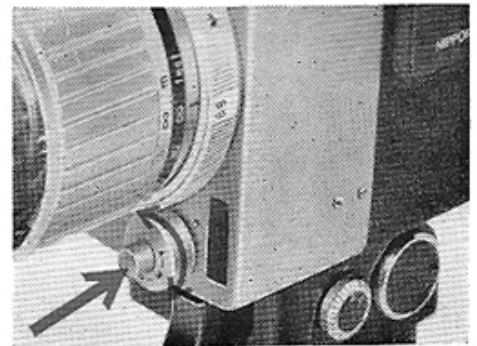

“NON-STANDARD” SHOOTING CONDITIONS

Running Speed Control

As previously mentioned, standard silent shooting speed is 18 frames-per-second. Sound speed is 24 frames-per-second. The Running Speed Control ⑱ has a third position: 12 frames-per-second.

If the light is too dim to shoot at 18 or 24 fps, correct exposure will often be achieved by selecting 12 fps. Of course, everything moving in the scene will appear to be speeded up, so its best to use this speed when only stationary objects appear in the scene.

On the other hand, this “speed-up” effect is often desired for comedy effects. In this case, the 12 frames-per-second position may be selected at any time. Similarly, the 24 fps position will have the effect of slowing everything down slightly, if the normal film speed is 18 fps. This is a kind of creative control your Nikon gives you for special-effects filming.

The automatic exposure system is keyed to the Speed Control, and it automatically compensates when the filming speed is changed.

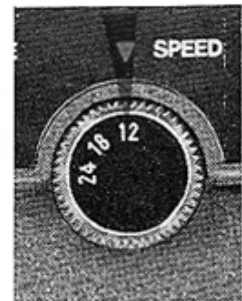
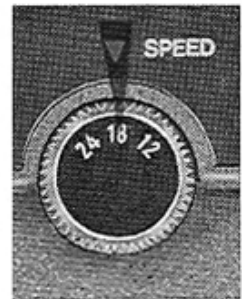

Manual Exposure Control

It is sometimes desirable to set exposure manually rather than automatically, to compensate for back-lighting or strong sidelighting or for special effects. (For example, simulated moonlight shot by bright sunlight may be achieved by a 2 f-number underexposure.) To select an aperture setting manually, push in on the A-M-C Ring Lock ⑥, and move the A-M-C Ring anywhere off “A”. Then, look through the viewfinder and rotate the ring until the aperture needle points to the desired f-number. The automatic exposure setting selected by the camera may be used as a reference for correct exposure when a deliberate over- or under-exposure is desired.

AFTER YOUR SHOOTING SESSION

When the full 50 feet of film have been exposed, a red square will appear in the lower left corner of the viewfinder. The Footage Counter will now read "50".

■ To Unload the Camera

Open the Cartridge Chamber Cover and lift up the rear end of the cartridge. The cartridge may then be lifted out of the camera. The word "EXPOSED" will be visible on the end of the film. Take the cartridge to your dealer for processing as soon as possible. It will be returned to you as 50 feet of processed film, on a reel, ready for projection.

■ When the Camera is not in Use

Retract the Pistol Grip by pressing down on the Grip Release-Lock ⑬ and swinging the Pistol Grip up until the Latch ⑭ clicks onto the Latch Pin ⑮.

Turn the Run-Lock Control to "L" position.

Replace the lens cover, and the camera is ready for storage. If the camera is to be stored for a long period of time, it is a good idea to remove the penlite batteries from the Pistol Grip. The mercury batteries, however, may safely be permitted to remain in the camera.

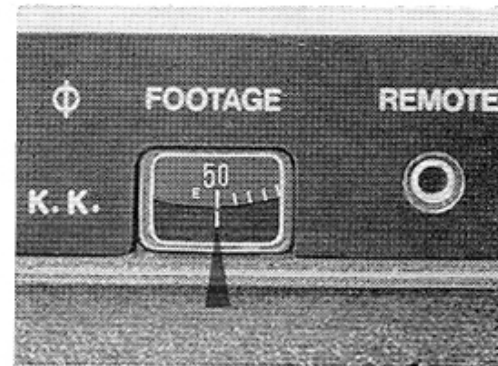

SPECIAL EFFECTS AND USES

■ Fade-In and Fade-Out

Turning the A-M-C Ring ⑦ to "C" (closed) position closes the lens diaphragm completely, allowing no light to pass. This permits marking fade-out and fade-in effects in the camera.

To fade-out at the end of a scene, set exposure manually. The automatic exposure system may be used to determine correct exposure setting. Then, at the end of the scene, slowly turn the Ring until it reaches "C" and will turn no further. This will cause a gradual dimming of the scene to complete blackness.

To fade-in, do just the opposite. Determine the correct exposure setting. Then, turn the Ring to "C" position. Start the camera and, while looking through the viewfinder, turn the Ring until the aperture needle points to the correct f-number, then, continue shooting the scene.

If the time for fade-in or out takes 3—5 seconds, the best will be obtained.

It is always recommended to mount the camera on a tripod or some other firm support while

shooting fade-in and fade-out effects, to avoid jarring the camera and causing an unpleasant bouncing effect on the screen when the film is shown. When using a tripod with a long thread length, be careful not to forcibly screw in the thread further than the depth of the socket.

■ Remote Control Filming

An accessory remote control cable is available from your Nikon dealer. The free end of this cable plugs into the Remote Control Socket ⑱, thereafter set the Run-Lock Control to "L" position which the Trigger is being depressed. The controls on the other end of the ten-foot cable are then used to

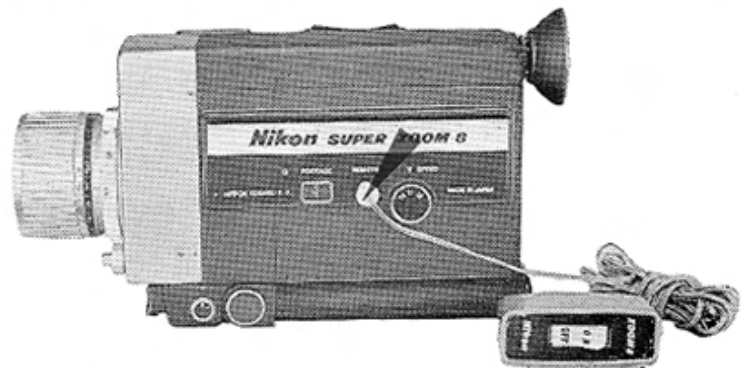

start and stop the camera. This feature enables you to take movies of yourself! It is also extremely useful for filming nature studies of shy wildlife creatures, or for filming in hazardous or uncomfortable areas.

Note: When filming with your eye away from the camera, such as in remote control filming, take care not to expose the finder eyepiece to intense light to prevent "flare" on the film caused by the light passing through the finder. It is advisable to cover the finder eyepiece with cloth or something. In remote control filming, it sometimes occurs that one or two frames between continuous runnings become white. This is because of camera mechanism, and not of camera trouble.

■ Single-Frame Exposures

To expose one frame of film at a time, insert a standard cable release into the Single-Frame Socket [Ⓜ]. Each time the cable release is actuated, one frame of film will be exposed. This is a useful feature for making animations... bringing objects to life and having them skitter across a table-top. For this effect, the object is moved a quarter-inch or so before each exposure.

Again, to obtain maximum camera steadiness while the single-frame feature is being used, the camera should be mounted on a tripod or a similar support.

Use the manual aperture setting (not the EE) at all times.



FILMING INDOORS AND OUTDOORS

A type-A filter is built into the camera. This filter converts outdoor light so it may be used with tungsten-balanced (Type-A) film. The filter is normally in the light path, so no action need be taken when filming outdoors with Type-A film.

When filming indoors with a Super-8 Movie Light, the key of the light is inserted in the Movie-Light Slot ③. The dust cover that protects this slot when it is not in use is easily removed.

If photofloods or other movie lights not equipped with the key are used, the special key provided with the camera is used to swing the Type-A filter out of the light path. Insert the key into the Slot. Remove it after the shooting session is ended, and replace the dust cover. Put the key through the wrist strap, so as not be misplaced.

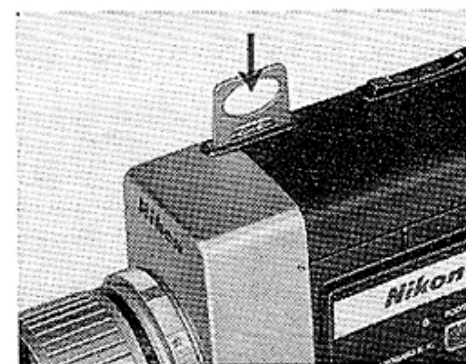
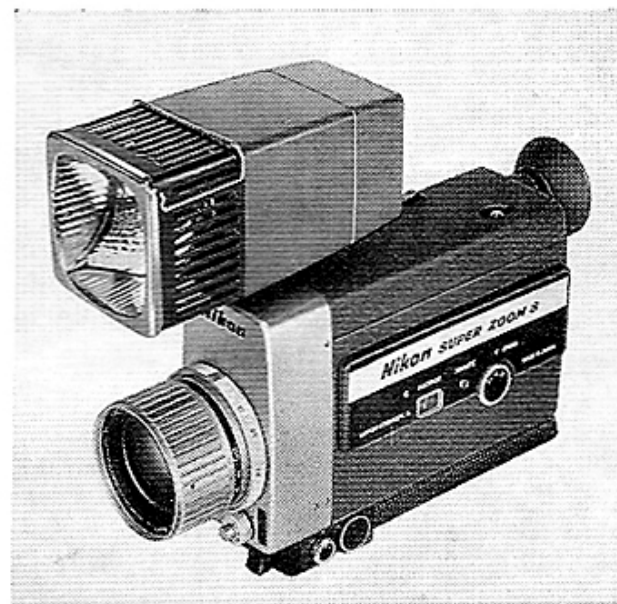

CLEANING YOUR CAMERA

■ The Lens

Clean the lens **infrequently**, every two or three months, unless the camera has been used in very dusty places.

Remove large dirt particles with a blower brush. Remove grime with a lens tissue, slightly moistened with lens cleaning fluid.

Always keep the lens capped when the camera is not in use.

NEVER SCRUB OR RUB THE LENS SURFACE.

This will damage the fine chemical coating of the lens.

And, **NEVER USE A FACIAL TISSUE OR HANDKERCHIEF.**

The former will leave a lint deposit on the lens; the latter will scratch the lens surface.

An exception to the rule about infrequent cleaning: remove finger-marks immediately.

Body acids can etch the fingerprint into the coating of the lens, making it impossible to remove.

■ The Camera's Interior

Clean the inside of the camera by blowing out dirt and film particles with a blower brush. Then, dust the inside fully.

Clean the film aperture with a soft brush, and remove film and stubborn dust particles with a cotton-tipped stick. (A lens tissue wrapped around a toothpick is useful). **NEVER CLEAN THE FILM APERTURE WITH ANYTHING METALLIC.** You may scratch its fine, polished surfaces and transfer the scratches to the film. Store the camera in its original container or the accessory carrying-case when it is not in use.

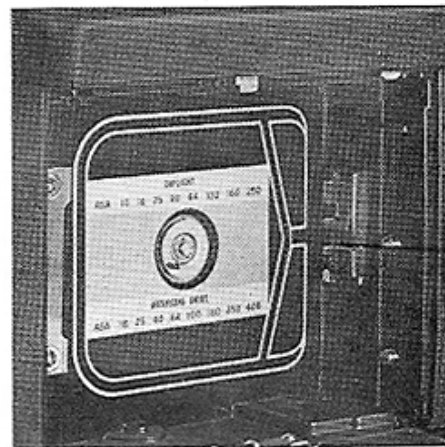

Film Aperture Plate

SOME FILMING TIPS

◆ **Keep the camera level**

Hold the camera perfectly level to the horizon when you're shooting. A tipped horizon line is unpleasant to view on the screen.

◆ **Hold the camera steady**

It's a very good rule of thumb that the camera should remain rock-steady, and the subject move within the frame. If you must move the camera, as in a "pan" shot, make the movement very slow and as smooth as you possibly can.

◆ **Don't over-zoom**

The zoom lens of your camera is such a delightful feature that there's a constant temptation to put a zoom effect in every shot. Don't do it. Use the zoom effect very sparingly, or it will lose its impact on your audience.

◆ **Keep your shot long enough ... but not too long**

Avoid short bursts. Make each shot at least 7 seconds in length. Where there's lots of interesting action, hold the shot even longer. If a shot is too long, you can always trim it in editing...but you can't use what you neglected to shoot!

◆ **Shoot children from low angles**

Kneel down when you make shots of children. Better yet, get flat down on your stomach. You'll get a view of the world as a child sees it...and you'll avoid the unpleasant foreshortening effect that distorts pictures of children when they're shot from adult height.

◆ **Keep the sun behind you**

You'll get best results if the sun is anywhere behind you, from shoulder to shoulder.

◆ **Shoot "Re-Action" Shots**

While you're filming some kind of event, shoot close-ups of spectators' faces reacting to what's going on. Splice these into the main footage, and they'll add a dramatic element to your filming efforts.

◆ **When Shooting From A Car**

Set the lens at wide angle; shoot preferably at 24 frames-per-second and point the camera no more than 45 degrees away from the direction in which the car is traveling. All this will help to smooth out bumps and prevent blurring the picture. Shooting directly **across** the direction of travel will cause an unpleasant blurry appearance.

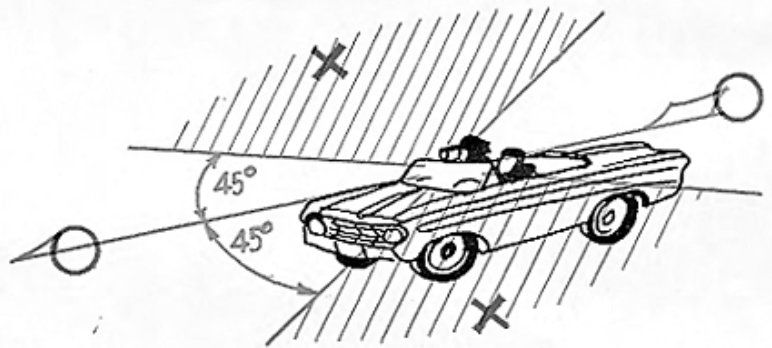

ACCESSORIES

■ Filters

Filters are colored discs of optical glass that are placed in front of the lens to improve the quality of the image. Your camera accepts 52 mm size filters and other front-of-the-lens attachments. The following types of filters are available from your Nikon dealer: Y48, L1A, L39, ND4x, ND8x, etc.



■ Lens Hood

52 mm diameter, convenient snap-on or screw-in mounting designed for Nikkor 50 mm f/1.4 or f/2 in F mount. Shades the lens against sun flare and stray light. Prevents fogging. Makes pictures more brilliant.



■ Leather Carry Case

Smooth, black cowhide, firmly stitched and reinforced at all stress-points. Holds the Nikon Super Zoom-8 camera, with lens hood and supply of film cartridges. Chromed lock. Adjustable shoulder strap.



■ Remote Control Switch with Cable

Fits into the remote control socket of the camera, and permits filming up to 10 feet away.



Close-Up Attachments

These are supplementary lenses that permit focusing the lens closer than its normal 4' limit. Three powers are available:

No. 0, No. 1 and No. 2.

The right tables give the focused distance, subject area and the depth-of-field, with the lens set at the focal lengths 8.8 mm and 45 mm, for each of the three powers. Values are given for both ends of the focus range, infinity and 4'. The split-image rangefinder may be used for sharp focusing with the close-up attachment in position.

(in inch system)

Close-up Lens No.	Lens Setting (ft)	Focused Distance (in)	Zoom ring Setting f (mm)	Subject Area (in) × (in)	Depth-of-Field (in)			
					f / 5.6	f / 8	f / 11	f / 16
No. 0	∞	61.0"	8.8	35.5" × 25.1"	28.7"–∞	23.8"–∞	19.8"–∞	15.7"–∞
			45	6.7" × 5.0"	58.0"–63.5"	56.9"–64.8"	55.6"–66.6"	53.6"–69.7"
	4'	29.5"	8.8	13.9" × 10.4"	20.8"–50.9"	18.7"–77.6"	16.6"–246"	14.2"–∞
			45	2.8" × 2.1"	29.0"–30.0"	28.8"–30.2"	28.6"–30.4"	28.2"–30.9"
No. 1	∞	31.5"	8.8	16.0" × 12.0"	20.9"–67.0"	18.5"–145"	16.3"–∞	13.7"–∞
			45	3.2" × 2.4"	30.9"–32.1"	30.6"–32.4"	30.3"–32.8"	29.8"–33.4"
	4'	21.6"	8.8	9.4" × 7.0"	16.9"–28.9"	15.7"–34.6"	14.4"–46.5"	12.7"–119"
			45	1.9" × 1.4"	21.4"–21.8"	21.3"–21.9"	21.2"–22.0"	21.0"–22.2"
No. 2	∞	18.3"	8.8	8.0" × 6.0"	14.7"–23.3"	13.7"–27.0"	12.7"–34.2"	11.3"–65.2"
			45	1.6" × 1.2"	18.1"–18.4"	18.1"–18.5"	18.0"–18.6"	17.8"–18.7"
	4'	15.3"	8.8	5.8" × 4.4"	13.1"–17.4"	12.4"–18.8"	11.8"–21.0"	10.8"–26.4"
			45	1.1" × 0.9"	15.2"–15.4"	15.2"–15.4"	15.2"–15.5"	15.1"–15.6"

(in metric system)

Close-up Lens No.	Lens Setting (m)	Focused Distance (cm)	Zoom ring Setting f (mm)	Subject Area (cm) × (cm)	Depth-of-Field (cm)			
					f / 5.6	f / 8	f / 11	f / 16
No. 0	∞	154.0	8.8	85.0 × 63.7	71.6–∞	60.5–∞	50.3–∞	39.9–∞
			45	17.0 × 12.7	147.2–161.3	143.8–164.7	141.2–169.1	136.0–177.0
	1.2	74.3	8.8	35.3 × 26.4	52.6–126.9	47.2–191.0	42.1–559.5	35.9–∞
			45	7.0 × 5.2	73.1–75.5	72.6–76.0	72.0–76.7	71.0–77.8
No. 1	∞	80.0	8.8	40.6 × 30.5	53.1–170.2	47.0–366.9	41.3–∞	34.8–∞
			45	8.1 × 6.1	78.4–81.6	77.8–82.3	77.0–83.2	75.7–84.8
	1.2	54.6	8.8	23.9 × 17.8	42.9–72.7	39.7–86.8	36.4–116.1	32.2–285.8
			45	4.8 × 3.6	54.1–55.1	53.8–55.4	53.6–55.7	53.1–56.2
No. 2	∞	46.4	8.8	20.3 × 15.2	37.2–59.0	34.7–68.6	32.1–86.9	28.7–165.6
			45	4.1 × 3.0	46.0–46.8	45.9–47.0	45.7–47.2	45.3–47.6
	1.2	38.8	8.8	14.7 × 11.2	33.1–43.9	31.6–47.5	29.9–53.0	27.5–66.4
			45	2.9 × 2.2	38.6–39.0	38.5–39.1	38.4–39.2	38.2–39.4

"DEPTH-OF-FIELD" TABLE (in inch system)

DEPTH-OF-FIELD for f=8.8 mm								
Focused Distance (ft)	f/1.8	f/2	f/2.8	f/4	f/5.6	f/8	f/11	f/16
∞	11' 6" - ∞	10' 4" - ∞	7' 4" - ∞	5' 2" - ∞	3' 8" - ∞	2' 7" - ∞	1' 11" - ∞	1' 4" - ∞
30	8' 5" - ∞	7' 10" - ∞	6' 1" - ∞	4' 7" - ∞	3' 5" - ∞	2' 6" - ∞	1' 11" - ∞	1' 5" - ∞
15	6' 8" - ∞	6' 4" - ∞	5' 2" - ∞	4' 1" - ∞	3' 2" - ∞	2' 5" - ∞	1' 11" - ∞	1' 5" - ∞
10	5' 6" - 66' 3"	5' 3" - 183'	4' 5" - ∞	3' 7" - ∞	2' 11" - ∞	2' 3" - ∞	1' 10" - ∞	1' 4" - ∞
7	4' 6" - 16' 9"	4' 4" - 19' 11"	3' 9" - 83' 3"	3' 2" - ∞	2' 7" - ∞	2' 1" - ∞	1' 8" - ∞	1' 4" - ∞
6	4' 1" - 11' 10"	3' 11" - 13' 4"	3' 6" - 26' 9"	2' 11" - ∞	2' 6" - ∞	2' 0" - ∞	1' 8" - ∞	1' 3" - ∞
5	3' 7" - 8' 5"	3' 6" - 9' 1"	3' 2" - 13' 9"	2' 9" - 61' 10"	2' 4" - ∞	1' 11" - ∞	1' 7" - ∞	1' 3" - ∞
4 ½	3' 4" - 7' 0"	3' 3" - 7' 6"	2' 11" - 10' 5"	2' 7" - 24' 10"	2' 2" - ∞	1' 10" - ∞	1' 6" - ∞	1' 3" - ∞
4	3' 1" - 5' 10"	3' 0" - 6' 2"	2' 9" - 7' 11"	2' 5" - 14' 2"	2' 1" - ∞	1' 9" - ∞	1' 6" - ∞	1' 2" - ∞

The depth-of-field is measured from the film plane marked ϕ on the side of the camera.

DEPTH-OF-FIELD

for f=15 mm

Focused Distance (ft)	f/1.8	f/2	f/2.8	f/4	f/5.6	f/8	f/11	f/16
∞	33' 3" — ∞	29' 11" — ∞	21' 4" — ∞	14' 11" — ∞	10' 8" — ∞	7' 6" — ∞	5' 5" — ∞	3' 9" — ∞
30	15' 10" —293'	15' 1" — ∞	12' 7" — ∞	10' 1" — ∞	8' 0" — ∞	6' 1" — ∞	4' 9" — ∞	3' 5" — ∞
15	10' 5" —27' 1"	10' 1" —29' 8"	8' 11" —49' 0"	7' 7" — ∞	6' 4" — ∞	5' 1" — ∞	4' 1" — ∞	3' 1" — ∞
10	7' 9" —14' 2"	7' 7" —14' 10"	6' 11" —18' 5"	6' 1" —29' 0"	5' 3" —123'	4' 5" — ∞	3' 8" — ∞	2' 10" — ∞
7	5' 10" —8' 9"	5' 9" —9' 0"	5' 4" —10' 3"	4' 10" —12' 9"	4' 4" —19' 3"	3' 9" —79' 11"	3' 2" — ∞	2' 7" — ∞
6	5' 2" —7' 3"	5' 1" —7' 5"	4' 9" —8' 3"	4' 4" —9' 9"	3' 11" —13' 1"	3' 5" —26' 10"	3' 0" — ∞	2' 5" — ∞
5	4' 5" —5' 10"	4' 4" —5' 11"	4' 1" —6' 5"	3' 10" —7' 4"	3' 6" —9' 0"	3' 1" —13' 11"	2' 9" —43' 7"	2' 3" — ∞
4 ½	4' 0" —5' 2"	3' 11" —5' 3"	3' 9" —5' 7"	3' 6" —6' 3"	3' 3" —7' 6"	2' 11" —10' 6"	2' 7" —21' 7"	2' 2" — ∞
4	3' 7" —4' 6"	3' 7" —4' 7"	3' 5" —4' 10"	3' 3" —5' 4"	3' 0" —6' 2"	2' 8" —8' 1"	2' 5" —13' 3"	2' 1" — ∞

DEPTH-OF-FIELD for f=20 mm

Focused Distance (ft)	f/1.8	f/2	f/2.8	f/4	f/5.6	f/8	f/11	f/16
∞	59' 9" — ∞	53' 9" — ∞	38' 5" — ∞	26' 11" — ∞	19' 3" — ∞	13' 5" — ∞	9' 9" — ∞	6' 9" — ∞
30	20' 0" —60' 1"	19' 3" —67' 7"	16' 11" —136'	14' 3" — ∞	11' 9" — ∞	9' 4" — ∞	7' 5" — ∞	5' 6" — ∞
15	12' 0" 20' 0"	11' 9" —20' 9"	10' 10" —24' 6"	9' 8" —33' 7"	8' 6" —66' 7"	7' 2" — ∞	6' 0" — ∞	4' 8" — ∞
10	8' 7" —12' 0"	8' 6" —12' 3"	8' 0" —13' 5"	7' 4" —15' 9"	6' 7" —20' 7"	5' 9" —37' 7"	5' 0" — ∞	4' 1" — ∞
7	6' 3" —7' 11"	6' 3" —8' 0"	5' 11" —8' 6"	5' 7" —9' 5"	5' 2" —10' 11"	4' 8" —14' 3"	4' 2" —23' 6"	3' 6" — ∞
6	5' 6" —6' 8"	5' 5" —6' 9"	5' 3" —7' 1"	4' 11" —7' 8"	4' 7" —8' 8"	4' 2" —10' 7"	3' 9" —15' 0"	3' 3" —47' 6"
5	4' 8" —5' 5"	4' 7" —5' 6"	4' 5" —5' 9"	4' 3" —6' 1"	4' 0" —6' 8"	3' 8" —7' 10"	3' 4" —9' 11"	2' 11" —18' 1"
4 ½	4' 2" —4' 10"	4' 2" —4' 11"	4' 1" —5' 1"	3' 11" —5' 4"	3' 8" —5' 10"	3' 5" —6' 8"	3' 2" —8' 1"	2' 9" —12' 10"
4	3' 9" —4' 3"	4' 9" —4' 4"	3' 8" —4' 5"	3' 6" —4' 8"	3' 4" —5' 0"	3' 1" —5' 7"	2' 11" —6' 7"	2' 7" —9' 5"

DEPTH-OF-FIELD for f=30 mm

Focused Distance (ft)	f/1.8	f/2	f/2.8	f/4	f/5.6	f/8	f/11	f/16
∞	136'—∞	122'—∞	87' 2"—∞	61' 1"—∞	43' 7"—∞	30' 6"—∞	22' 2"—∞	15' 3"—∞
30	24' 7" —38' 7"	24' 1" —39' 10"	22' 4" —45' 10"	20' 1" —59' 1"	17' 9" —96' 5"	15' 1"—∞	12' 8"—∞	10' 1"—∞
15	13' 6" —16' 11"	13' 4" —17' 1"	12' 9" —18' 2"	12' 0" —19' 11"	11' 2" —22' 11"	10' 0" —29' 7"	8' 11" —46' 5"	7' 6"—∞
10	9' 4" —10' 10"	9' 3" —10' 11"	9' 0" —11' 4"	8' 7" —12' 0"	8' 1" —13' 0"	7' 6" —14' 11"	6' 10" —18' 3"	6' 0" —29' 2"
7	6' 8" —7' 5"	6' 7" —7' 5"	6' 6" —7' 7"	6' 3" —7' 11"	6' 0" —8' 4"	5' 8" —9' 1"	5' 4" —10' 3"	4' 9" —13' 0"
6	5' 9" —6' 3"	5' 9" —6' 4"	5' 7" —6' 5"	5' 6" —6' 8"	5' 3" —7' 0"	5' 0" —7' 6"	4' 9" —8' 3"	4' 3" —9' 11"
5	4' 10" —5' 2"	4' 10" —5' 3"	4' 9" —5' 4"	4' 7" —5' 5"	4' 6" —5' 8"	4' 3" —6' 0"	4' 1" —6' 6"	3' 9" —7' 6"
4 ½	4' 4" —4' 8"	4' 4" —4' 8"	4' 3" —4' 9"	4' 2" —4' 10"	4' 1" —5' 0"	3' 11" —5' 4"	3' 9" —5' 8"	3' 6" —6' 5"
4	3' 11" —4' 2"	3' 10" —4' 2"	3' 10" —4' 2"	3' 9" —4' 3"	3' 8" —4' 5"	3' 6" —4' 7"	3' 5" —4' 11"	3' 2" —5' 5"

DEPTH-OF-FIELD for f=45 mm

Focused Distance (ft)	f/1.8	f/2	f/2.8	f/4	f/5.6	f/8	f/11	f/16
∞	287'—∞	259'—∞	185'—∞	129'—∞	92' 4"—∞	64' 8"—∞	47' 0"—∞	32' 4"—∞
30	27' 1" —33' 7"	26' 10" —34' 0"	25' 9" —35' 11"	24' 3" —39' 3"	22' 6" —44' 9"	20' 4" —56' 7"	18' 2" —84' 5"	15' 4"—∞
15	14' 3" —15' 10"	14' 2" —16' 0"	13' 10" —16' 5"	13' 5" —17' 1"	12' 10" —18' 0"	12' 1" —19' 8"	11' 3" —22' 4"	10' 1" —28' 7"
10	9' 8" —10' 5"	9' 7" —10' 5"	9' 6" —10' 7"	9' 3" —10' 11"	9' 0" —11' 3"	8' 7" —11' 11"	8' 2" —12' 10"	7' 6" —14' 9"
7	6' 10" —7' 2"	6' 10" —7' 3"	6' 9" —7' 4"	6' 7" —7' 5"	6' 6" —7' 7"	6' 3" —7' 11"	6' 0" —8' 4"	5' 8" —9' 1"
6	5' 10" —6' 2"	5' 10" —6' 2"	5' 10" —6' 3"	5' 9" —6' 4"	5' 7" —6' 5"	5' 5" —6' 8"	5' 3" —6' 11"	5' 0" —7' 6"
5	4' 11" —5' 1"	4' 11" —5' 1"	4' 10" —5' 2"	4' 10" —5' 3"	4' 9" —5' 4"	4' 7" —5' 6"	4' 6" —5' 8"	4' 3" —6' 0"
4 ½	4' 5" —4' 7"	4' 5" —4' 7"	4' 5" —4' 8"	4' 4" —4' 8"	4' 3" —4' 9"	4' 2" —4' 11"	4' 1" —5' 0"	3' 11" —5' 4"
4	3' 11" —4' 1"	3' 11" —4' 1"	3' 11" —4' 1"	3' 10" —4' 2"	3' 10" —4' 2"	3' 9" —4' 4"	3' 8" —4' 5"	3' 6" —4' 8"

“ DEPTH-OF-FIELD ” TABLE (in metric system)

DEPTH-OF-FIELD for $f=8.8$ mm (m)								
Focused Distance (m)	$f/1.8$	$f/2$	$f/2.8$	$f/4$	$f/5.6$	$f/8$	$f/11$	$f/16$
∞	3.49 ~ ∞	3.14 ~ ∞	2.24 ~ ∞	1.57 ~ ∞	1.12 ~ ∞	0.79 ~ ∞	0.57 ~ ∞	0.43 ~ ∞
10	2.62 ~ ∞	2.42 ~ ∞	1.87 ~ ∞	1.39 ~ ∞	1.04 ~ ∞	0.76 ~ ∞	0.57 ~ ∞	0.43 ~ ∞
5	2.10 ~ ∞	1.98 ~ ∞	1.60 ~ ∞	1.25 ~ ∞	0.97 ~ ∞	0.73 ~ ∞	0.57 ~ ∞	0.42 ~ ∞
4	1.91 ~ ∞	1.81 ~ ∞	1.49 ~ ∞	1.19 ~ ∞	0.94 ~ ∞	0.72 ~ ∞	0.56 ~ ∞	0.42 ~ ∞
3	1.66 ~ 18.3	1.58 ~ 43.5	1.34 ~ ∞	1.09 ~ ∞	0.87 ~ ∞	0.68 ~ ∞	0.54 ~ ∞	0.41 ~ ∞
2.5	1.50 ~ 8.06	1.44 ~ 10.8	1.23 ~ ∞	1.02 ~ ∞	0.83 ~ ∞	0.66 ~ ∞	0.53 ~ ∞	0.40 ~ ∞
2	1.31 ~ 4.38	1.26 ~ 5.07	1.11 ~ 13.7	0.93 ~ ∞	0.78 ~ ∞	0.62 ~ ∞	0.51 ~ ∞	0.39 ~ ∞
1.7	1.18 ~ 3.13	1.14 ~ 3.45	1.01 ~ 6.00	0.87 ~ ∞	0.73 ~ ∞	0.60 ~ ∞	0.49 ~ ∞	0.38 ~ ∞
1.5	1.08 ~ 2.49	1.05 ~ 2.69	0.94 ~ 4.00	0.82 ~ 15.6	0.70 ~ ∞	0.57 ~ ∞	0.48 ~ ∞	0.37 ~ ∞
1.2	0.92 ~ 1.74	0.90 ~ 1.83	0.82 ~ 2.34	0.73 ~ 4.06	0.63 ~ ∞	0.53 ~ ∞	0.45 ~ ∞	0.36 ~ ∞

29 The depth-of-field is measured from the film plane marked ϕ on the side of the camera.

DEPTH-OF-FIELD for f=15 mm (m)

Focused Distance (m)	f/1.8	f/2	f/2.8	f/4	f/5.6	f/8	f/11	f/16
∞	10.12 ~ ∞	9.11 ~ ∞	6.51 ~ ∞	4.56 ~ ∞	3.25 ~ ∞	2.28 ~ ∞	1.66 ~ ∞	1.14 ~ ∞
10	5.05 ~ 6.22	4.79 ~ ∞	3.97 ~ ∞	3.15 ~ ∞	2.48 ~ ∞	1.88 ~ ∞	1.45 ~ ∞	1.05 ~ ∞
5	3.37 ~ 9.74	3.25 ~ 10.9	2.86 ~ 20.7	2.42 ~ ∞	2.01 ~ ∞	1.60 ~ ∞	1.28 ~ ∞	0.97 ~ ∞
4	2.89 ~ 6.54	2.80 ~ 7.04	2.50 ~ 10.1	2.16 ~ 29.9	1.83 ~ ∞	1.48 ~ ∞	1.21 ~ ∞	0.92 ~ ∞
3	2.33 ~ 4.22	2.28 ~ 4.42	2.08 ~ 5.45	1.84 ~ 8.43	1.59 ~ 31.5	1.33 ~ ∞	1.10 ~ ∞	0.86 ~ ∞
2.5	2.02 ~ 3.29	1.98 ~ 3.40	1.83 ~ 3.98	1.64 ~ 5.36	1.44 ~ 9.98	1.22 ~ ∞	1.03 ~ ∞	0.82 ~ ∞
2	1.68 ~ 2.47	1.65 ~ 2.53	1.55 ~ 2.84	1.41 ~ 3.46	1.27 ~ 4.92	1.10 ~ 13.6	0.94 ~ ∞	0.76 ~ ∞
1.7	1.47 ~ 2.02	1.45 ~ 2.07	1.36 ~ 2.26	1.26 ~ 2.64	1.14 ~ 3.40	1.00 ~ 6.05	0.87 ~ 298	0.72 ~ ∞
1.5	1.32 ~ 1.74	1.30 ~ 1.78	1.23 ~ 1.92	1.15 ~ 2.18	1.05 ~ 2.67	0.93 ~ 4.04	0.82 ~ 11.6	0.68 ~ ∞
1.2	1.08 ~ 1.35	1.07 ~ 1.37	1.03 ~ 1.45	0.97 ~ 1.59	0.90 ~ 1.83	0.81 ~ 2.38	0.72 ~ 3.82	0.62 ~ ∞

DEPTH-OF-FIELD

for f=20 mm

(m)

Focused Distance (m)	f/1.8	f/2	f/2.8	f/4	f/5.6	f/8	f/11	f/16
∞	18.2~∞	16.4~∞	11.7~∞	8.20~∞	5.85~∞	4.10~∞	2.98~∞	2.05~∞
10	6.46~22.1	6.22~25.5	5.40~67.4	4.55~∞	3.70~∞	2.92~∞	2.31~∞	1.71~∞
5	3.93~6.87	3.84~7.17	3.51~8.68	3.12~12.7	2.71~32.9	2.27~∞	1.88~∞	1.47~∞
4	3.29~5.11	3.22~5.27	2.99~6.04	2.70~7.74	2.39~12.4	2.04~123	1.72~∞	1.37~∞
3	2.58~3.58	2.54~3.66	2.40~4.01	2.21~4.69	2.00~6.06	1.75~10.8	1.51~535	1.24~∞
2.5	2.20~2.89	2.18~2.94	2.07~3.16	1.93~3.57	1.76~4.31	1.57~6.25	1.38~14.4	1.14~∞
2	1.81~2.24	1.79~2.27	1.72~2.40	1.62~2.62	1.50~3.00	1.36~3.82	1.21~5.83	1.03~47.4
1.7	1.56~1.87	1.54~1.89	1.49~1.98	1.42~2.13	1.33~2.37	1.21~2.85	1.10~3.83	0.95~8.96
1.5	1.39~1.63	1.38~1.65	1.34~1.71	1.28~1.82	1.20~1.99	1.11~2.32	1.01~2.93	0.88~5.20
1.2	1.13~1.28	1.12~1.29	1.09~1.33	1.05~1.40	1.00~1.49	0.94~1.67	0.87~1.96	0.77~2.75

DEPTH-OF-FIELD **for f=30 mm** (m)

Focused Distance (m)	f/1.8	f/2	f/2.8	f/4	f/5.6	f/8	f/11	f/16
∞	41.3~ ∞	37.2~ ∞	26.6~ ∞	18.6~ ∞	13.3~ ∞	9.30~ ∞	6.77~ ∞	4.65~ ∞
10	8.05~13.2	7.88~13.7	7.26~16.1	6.49~21.7	5.69~40.5	4.80~ ∞	4.02~ ∞	3.15~ ∞
5	4.46~5.69	4.40~5.78	4.20~6.17	3.93~6.85	3.62~8.03	3.24~10.8	2.86~19.2	2.39~ ∞
4	3.65~4.43	3.61~4.48	3.47~4.71	3.29~5.10	3.07~5.73	2.79~7.03	2.50~9.81	2.14~28.6
3	2.80~3.24	2.77~3.27	2.69~3.38	2.58~3.58	2.44~3.88	2.26~4.44	2.07~5.41	1.81~8.49
2.5	2.36~2.66	2.34~2.68	2.28~2.76	2.20~2.89	2.10~3.08	1.97~3.43	1.82~3.98	1.62~5.43
2	1.91~2.10	1.90~2.11	1.86~2.16	1.80~2.24	1.74~2.36	1.64~2.55	1.54~2.85	1.39~3.53
1.7	1.63~1.77	1.62~1.78	1.60~1.82	1.56~1.87	1.50~1.95	1.43~2.09	1.35~2.28	1.24~2.69
1.5	1.45~1.56	1.44~1.56	1.42~1.59	1.39~1.63	1.35~1.69	1.29~1.79	1.22~1.93	1.13~2.22
1.2	1.17~1.24	1.16~1.24	1.15~1.26	1.13~1.28	1.10~1.32	1.06~1.38	1.02~1.46	0.95~1.62

DEPTH-OF-FIELD

for f=45 mm

(m)

Focused Distance (m)	f/1.8	f/2	f/2.8	f/4	f/5.6	f/8	f/11	f/16
∞	87.6~∞	78.8~∞	56.3~∞	39.4~∞	28.2~∞	19.7~∞	14.3~∞	9.85~∞
10	8.96~11.3	8.86~11.5	8.47~12.2	7.95~13.5	7.34~15.6	6.59~20.5	5.84~33.7	4.90~∞
5	4.72~5.31	4.69~5.35	4.58~5.50	4.42~5.75	4.22~6.11	3.96~6.76	3.67~7.78	3.27~10.4
4	3.82~4.20	3.80~4.22	3.72~4.32	3.62~4.47	3.48~4.69	3.30~5.06	3.01~5.62	2.81~6.86
3	2.90~3.11	2.88~3.12	2.84~3.18	2.78~3.26	2.70~3.38	2.58~3.57	2.46~3.84	2.27~4.39
2.5	2.43~2.58	2.42~2.59	2.39~2.62	2.34~2.68	2.28~2.76	2.20~2.89	2.11~3.06	1.97~3.41
2	1.95~2.05	1.95~2.06	1.93~2.08	1.90~2.12	1.85~2.16	1.80~2.24	1.74~2.35	1.64~2.55
1.7	1.66~1.74	1.66~1.74	1.65~1.76	1.62~1.78	1.59~1.82	1.55~1.88	1.50~1.95	1.43~2.09
1.5	1.47~1.53	1.47~1.53	1.46~1.55	1.44~1.57	1.42~1.59	1.38~1.64	1.34~1.69	1.28~1.80
1.2	1.18~1.22	1.18~1.22	1.17~1.23	1.16~1.24	1.14~1.26	1.12~1.29	1.10~1.32	1.05~1.39